



Straightaway 100 Residential Sliding & Folding Door Systems

Door Specifications

- Maximum Door Weight: 100kg
- Door Thickness: 20mm - 50mm
Minimum door thickness 30mm when using channel
- Door Construction:
Timber framed, panelled or glazed with adequate top rail for secure fixing of hanger. Can also be used for metal doors of light angle or channel frame construction minimum thickness 40mm

- Maximum Door Height: 2700mm
- Track Dimensions:
28mm (w) x 30mm (h) Galvanised Steel
- Track Dimensions:
31mm (w) x 30mm (h) Aluminium

Hardware Specifications

- Top track can be soffit fixed or side fixed with additional brackets
- Range of bottom guiding available to achieve clear thresholds
- Side fixing brackets included in track sets

- Nylon wheeled hangers for smooth operation
- For single, bi parting or bi passing doors
- Detachable door plates enable easy and efficient installation
- Soffit and side fixed soft close available for doors up to 70kgs
- Self close available
- Hangers allow vertical and lateral adjustment

Straightaway 100

Residential Sliding & Folding Door Systems

Product Overview

Straightaway 100 is a top hung sliding door system for heavier weight doors. It can be used internally and externally and is suited to applications where large sliding doors are required to slide effortlessly such as room dividers and room entrances. It is an easy to fit reliable system.

Technical Specification

STRAIGHTAWAY 100

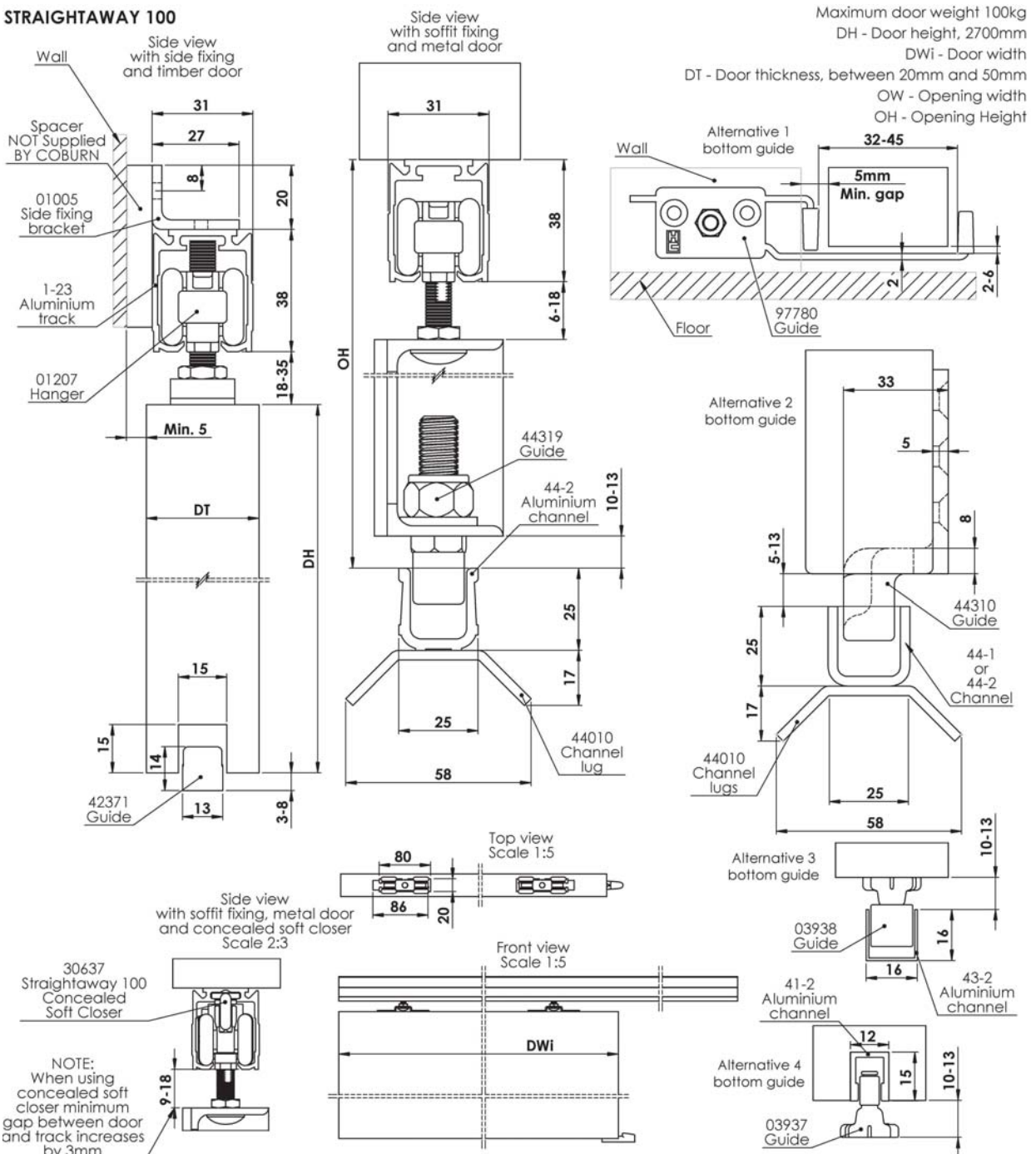









Residential
 Sliding & Folding
 Door Systems

For further information please contact us:

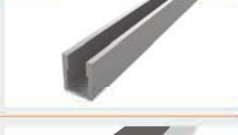
Tel: +44 (0)20 8545 6680 sales@coburn.co.uk www.coburn.co.uk

Straightaway 100

Residential Sliding & Folding Door Systems

| Article No. | Description | Image |
|-------------|--|---|
| 01218 | Trackset for one door up to 950mm |  |
| 01224 | Trackset for one door up to 1250mm |  |
| 123 | Anodised aluminium top track, available in 1.5, 1.8, 2.1, 2.4 and 3.0m lengths |  |
| 412 | Aluminium channel for use with 03937 guide, available in 1.5, 1.8, 2.1, 2.4 and 3.0m lengths |  |
| 432 | Aluminium channel for use with 03938 guide, available in 2.0, 2.4, 3.0, 3.6, 4.0 and 6.0m lengths |  |
| 442 | Aluminium channel for use with 44319 guide, available in 1.5, 1.8, 2.1, 2.4, 3.0, 3.6 and 6.0m lengths |  |
| 01725 | Track end piece (pair) |  |
| 01208 | Single door component pack |  |
| 01207 | Pair of nylon wheeled hangers |  |
| 01005 | Steel side fixing bracket (pack of 5) |  |
| 01008 | Steel side fixing bracket (pack of 8) |  |

| Article No. | Description | Image |
|-------------|--|---|
| 03937 | Adjustable rattleproof guide with 6mm roller. For use with 412 channel |  |
| 03938 | Adjustable rattleproof guide with 13mm ball bearing roller. For use with 432 channel |  |
| 44319 | Pair of nylon roller guides for metal doors. For use with 442 channel |  |
| 97780 | Adjustable guide for jamb fixing or interior doors up to 1500mm, 30-45mm thick |  |
| 30611 | Soft closer – side fix 70kg |  |
| 30613 | Soft closer – soffit fix 70kg |  |
| 30701 | Self closer – 100kg |  |
| 61401 | Simultaneous synchro kit for doors up to 800mm |  |
| 61403 | Simultaneous synchro kit for doors up to 1200mm |  |
| 95681 | Circular flush pull, 57mm Ø, polished brass (For our full range of accessories see pages 96-97) |  |

Trackset contents: Aluminium top track, brackets, nylon wheeled hangers, track end pieces with retaining catch, nylon floor guide designed to run in rebate in underside of door, spanner and all woodscrews.

Component pack contents: Nylon wheeled hangers, track end pieces with retaining catch, adjustable guide for fixing to reveal, spanner and all woodscrews.

Galvanised steel track and various other guiding options available.

Contact Coburn for further details.



For further information please contact us:

Tel: +44 (0)20 8545 6680 sales@coburn.co.uk www.coburn.co.uk

Straightaway 100

Residential Sliding & Folding
Door Systems



Residential
Sliding & Folding
Door Systems

For further information please contact us:

Tel: +44 (0)20 8545 6680 sales@coburn.co.uk www.coburn.co.uk

