

# FLAT TRACK MINI

Fitting instructions for 1.5m and 2m kits



## Technical Drawing

For Straight and Arrowhead Hanger Kit

Coburn Sliding Systems Limited

Unit 1, Cardinal West, Cardinal Way,

Godmanchester, PE29 2XN, United Kingdom

Phone: +44 (0)20 8545 6680

Fax: +44 (0)20 8545 6720

E-mail: sales@coburn.co.uk

www.coburn.co.uk

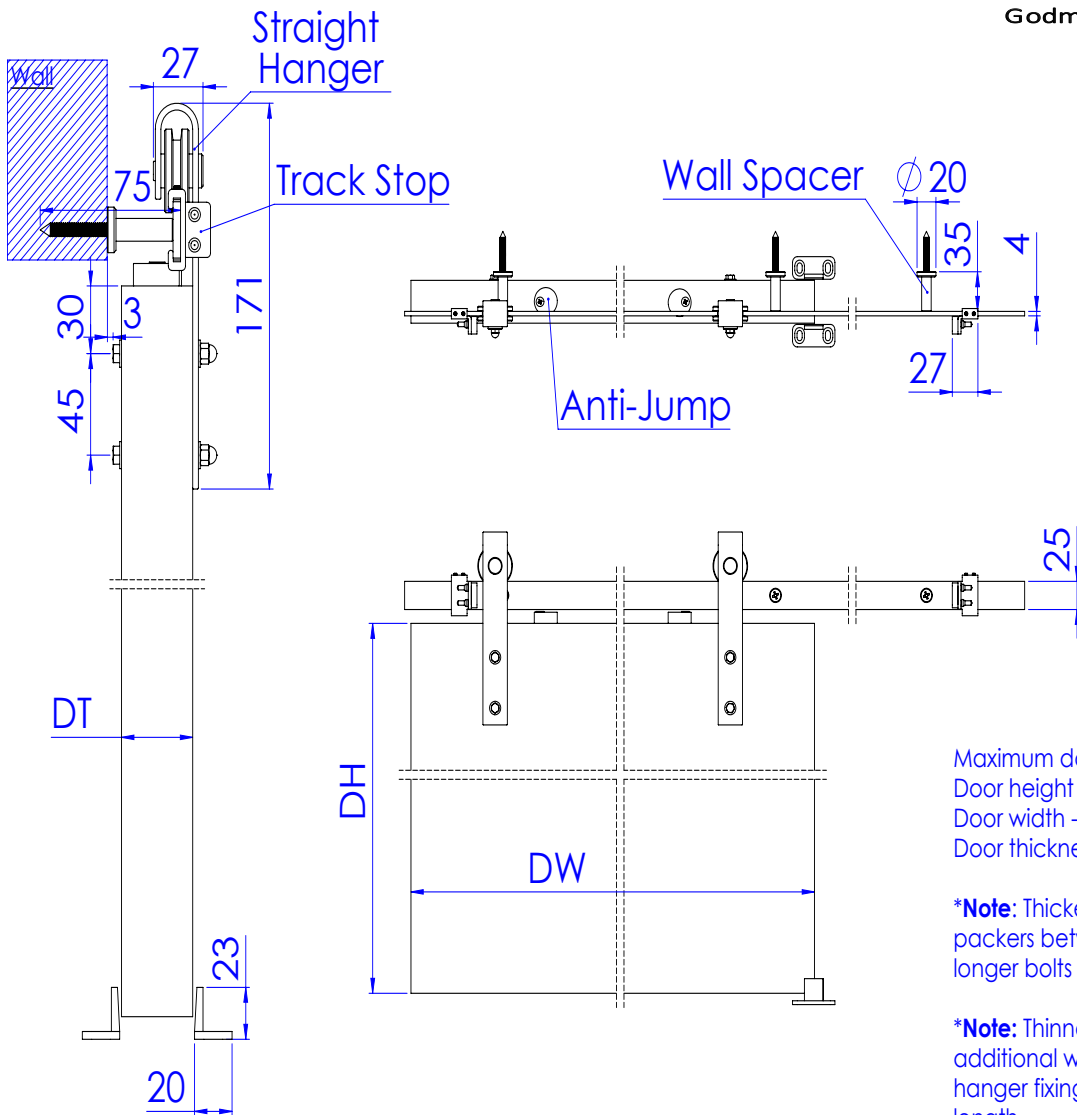

Maximum door weight 50kg  
 Door height - DH - Maximum 2400mm  
 Door width - DW - Minimum 500mm  
 Door thickness - DT - Between 25 and 38mm

**\*Note:** Thicker doors can be used with the addition of packers between the wall and wall spacers and longer bolts through the doors to secure hangers

**\*Note:** Thinner doors can also be used by adding additional washers between the door and the hanger fixing bolt or by cutting fixing bolt to required length

## Components

Choice of hangers



Track  
 Available in 1.5m  
 and 2m lengths

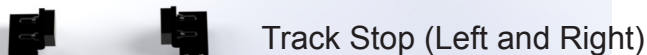

Track Stop (Left and Right)

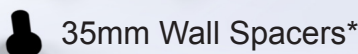

35mm Wall Spacers\*



75mm Countersunk Fixing Screw\*

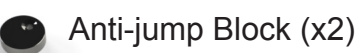

Anti-jump Block (x2)



Guide (x2)

\* Depending on length of track, quantity changes.  
 4x Screws and Spacers for 1.5m track  
 5x Screws and Spacers for 2.0m track

# Technical Drawing

For Top Mount Hanger Kit

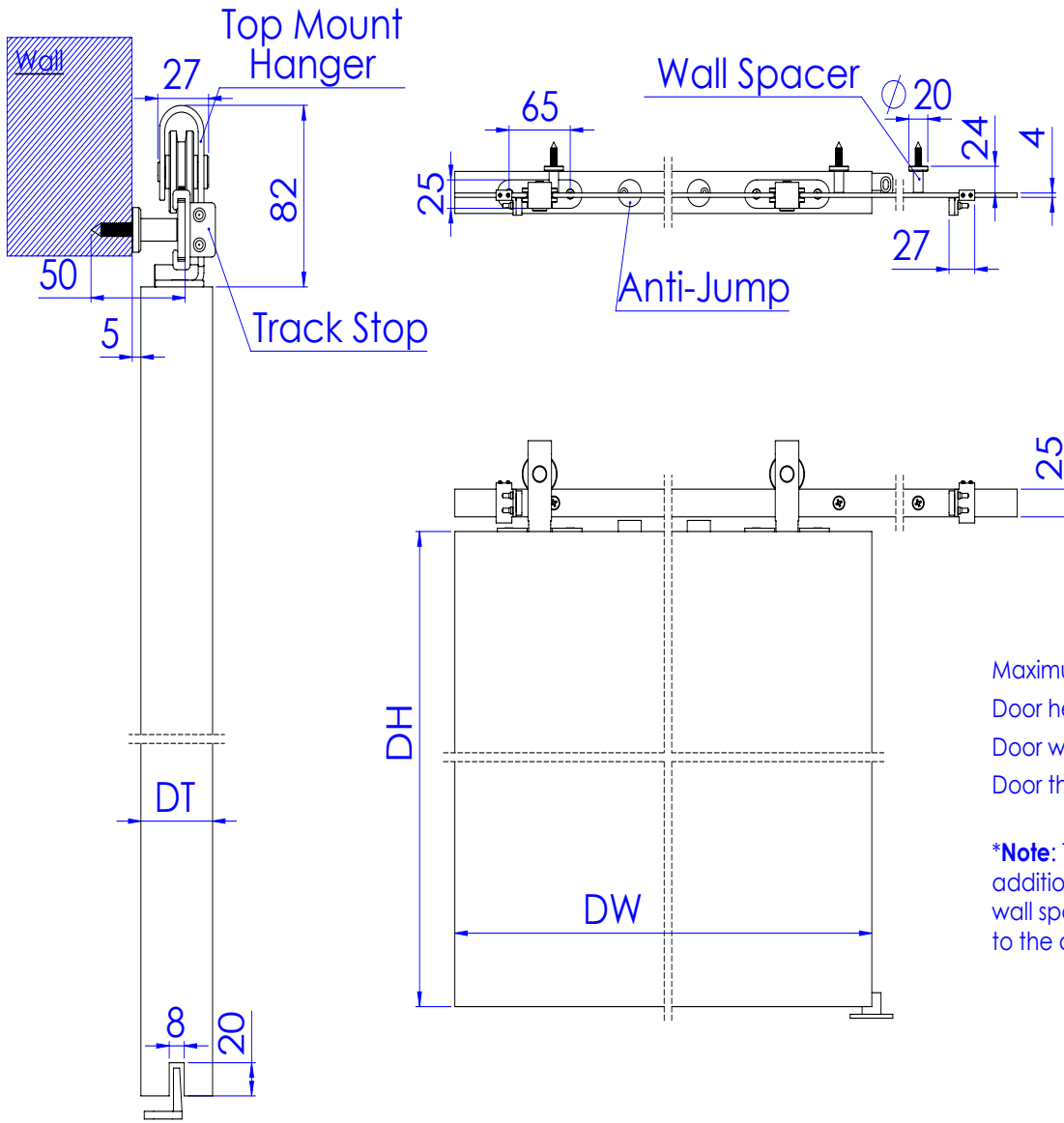

Maximum door weight 50kg  
 Door height - DH - Maximum 2400mm  
 Door width - DW - Minimum 500mm  
 Door thickness - DT - Between 25 and 38mm

**\*Note:** Thicker doors can be used with the addition of packers between the wall and wall spacers or positioning the hanger closer to the door edge

## Components

Hanger



Top Mount Hanger (Pair)

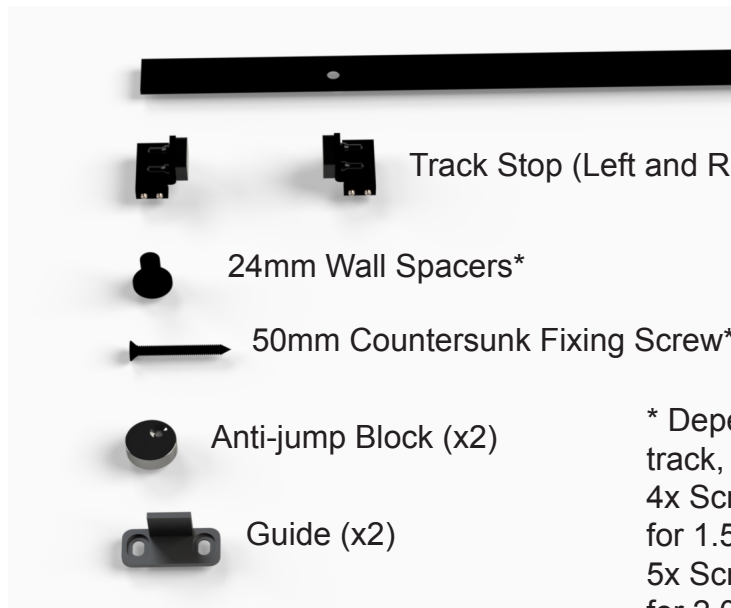

Track Available in 1.5m and 2m lengths

Track Stop (Left and Right)

24mm Wall Spacers\*

50mm Countersunk Fixing Screw\*

Anti-jump Block (x2)

Guide (x2)

\* Depending on length of track, quantity changes.  
 4x Screws and Spacers for 1.5m track  
 5x Screws and Spacers for 2.0m track

# Dimensions

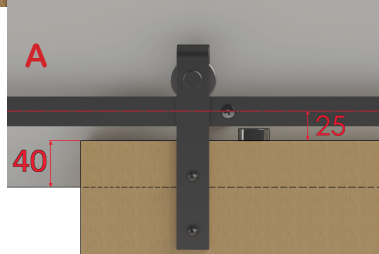
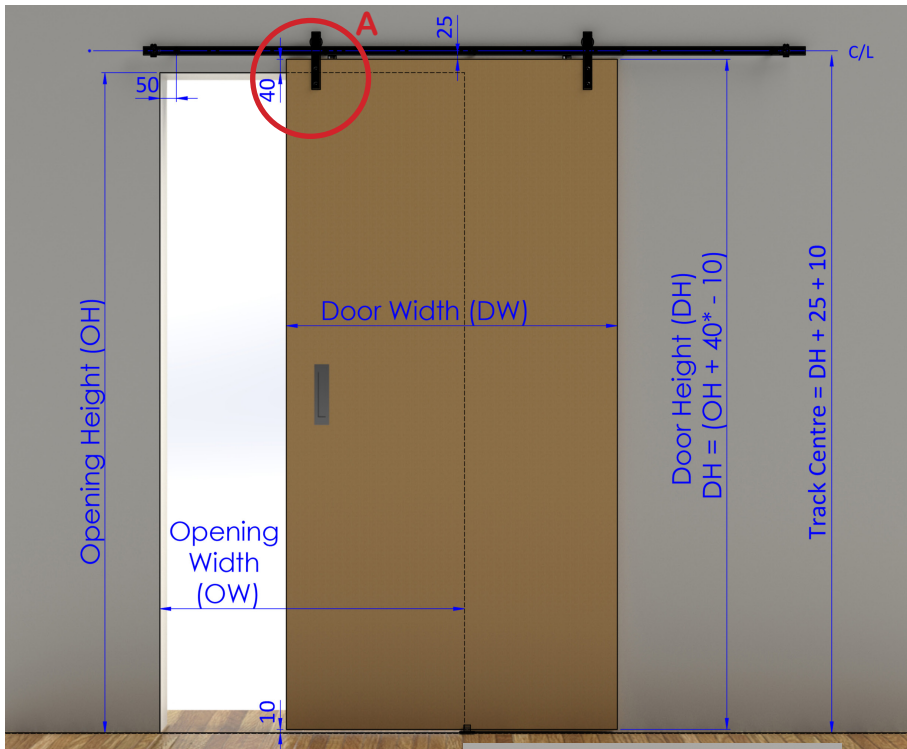

$DW = OW + 40^* + 40^*$   
 $(DW = OW + 80)$

\* Coburn suggested 40mm overlap of the door to the opening

## Step 1 Fixing track

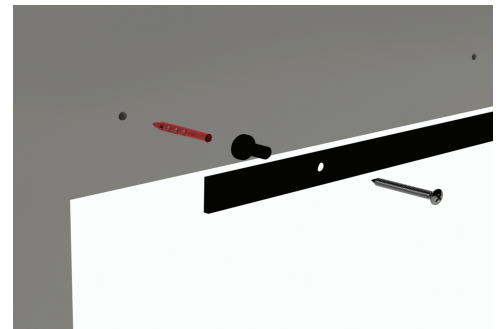
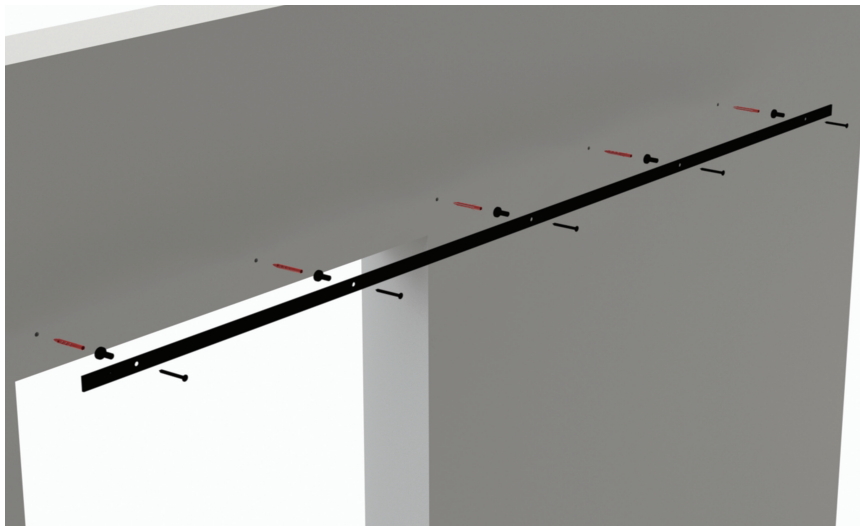
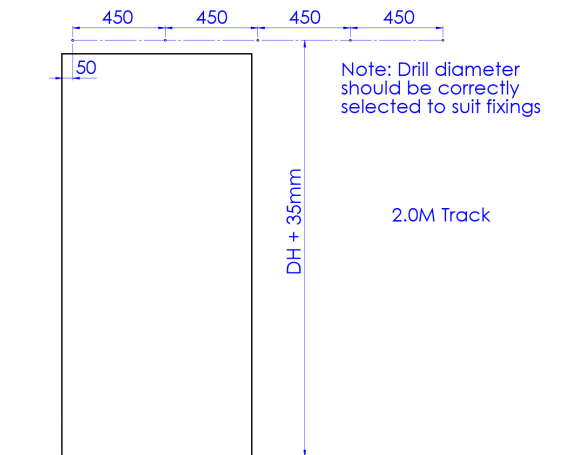
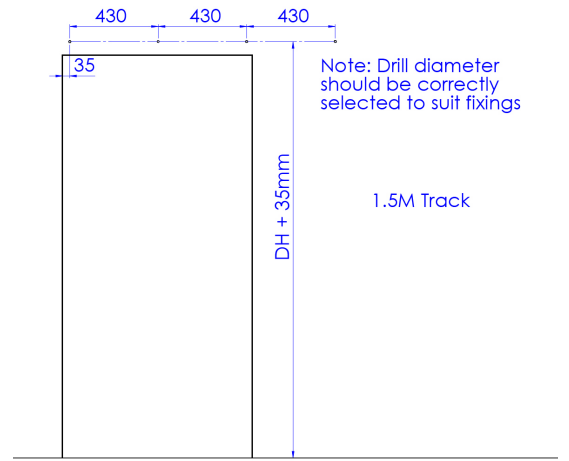

Recommended to use wall plugs when fixing track on to a masonry or brick wall  
 \*Wall plug not supplied by Coburn

1. Mark and drill pilot holes
2. Place track over spacer
3. Fix track with fixing screws supplied
4. Repeat steps above for the remaining screws and spacers
5. Use a spirit level or a laser level to ensure track is levelled
6. Tighten screws to keep track in a levelled position

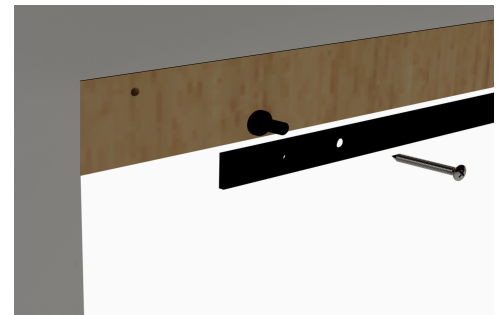

When fixing track on to timber frame wall recommended pilot hole diameter 5mm

## Step 2 Door Preparation

### Straight and Arrowhead hangers

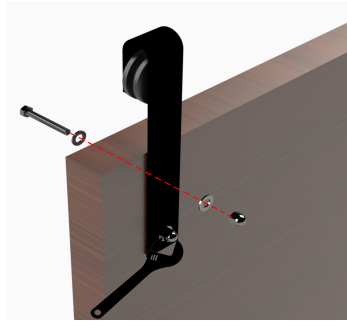
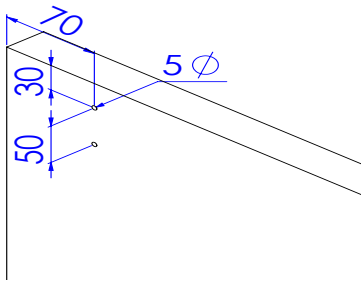

1. Make 2x 5mm holes through the door. First hole 30mm from the top of the door and second hole 45mm vertically down from the first hole. Drill 2x 5mm on the other side of the door.
2. Align the hanger holes with the holes made in the door.
3. Insert bolts and washer through the door and hanger. Make sure the securing nut is tightened on the plate of the hanger

### Top Mount hangers

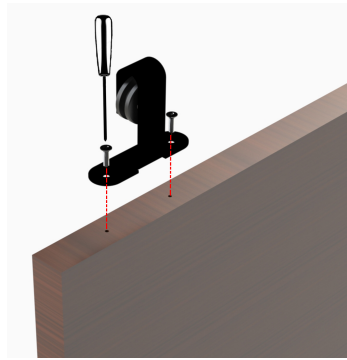
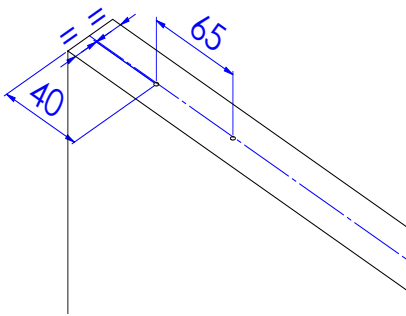

1. Recommended to drill 2x 2mm pilot hole 65mm apart on the top of the door, along the center line. Drill 2 more pilot holes on the other side of the door.
2. Place the hanger on top of the door and position holes on top of the pilot holes just made
3. Secure hanger with the screws provided

**Note\*** If using a thicker than 38mm door without packers, position the top mount hanger off from the center line towards the door edge that will be closest to the wall

### Concealed guide prep

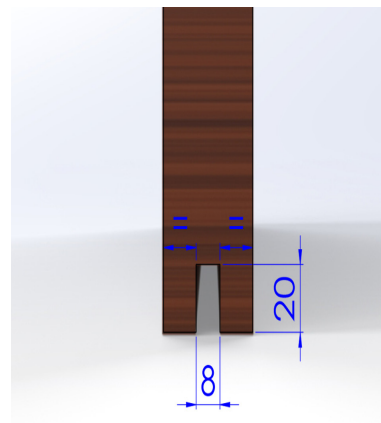
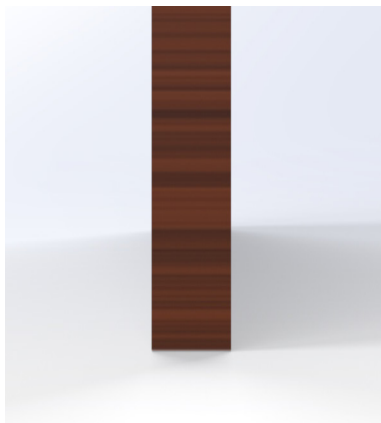

For concealed floor guide route 8mm x 20mm channel in the bottom of the door to accommodate guide.

**Note\*** Routing this channel is not needed if you are using the 2 guides provided.  
For instructions on this method follow step 6



### Step 3 Fit door on track

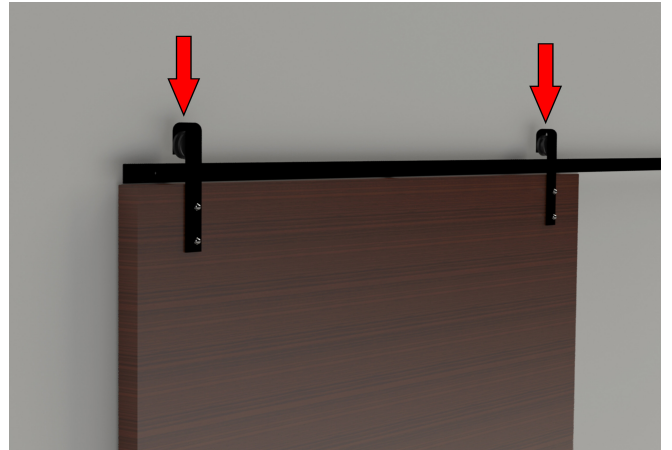
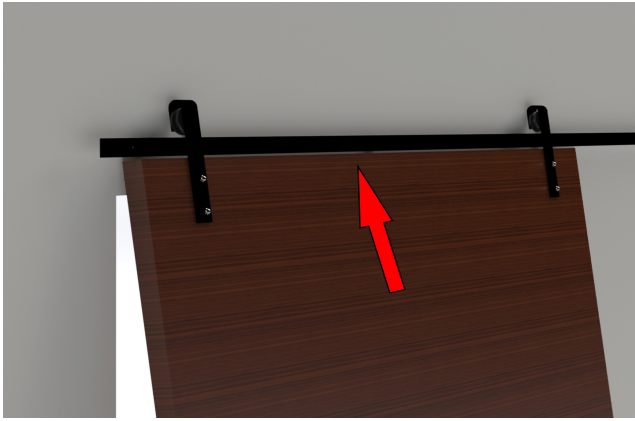

Position the hangers over track and without damaging the track slowly lower the door and hangers onto the track until they sit on the top of the track

### Step 4 Fit anti-jump blocks

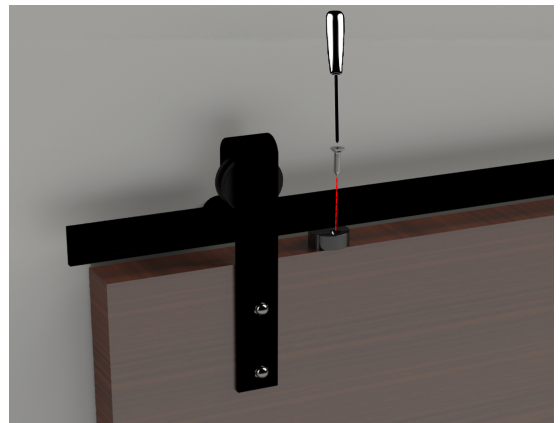
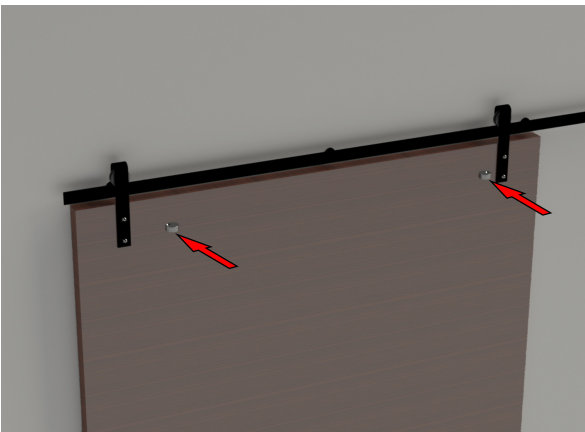

Place anti-jump blocks on top of the door and secure with supplied screws

### Step 5 Fit track stoppers

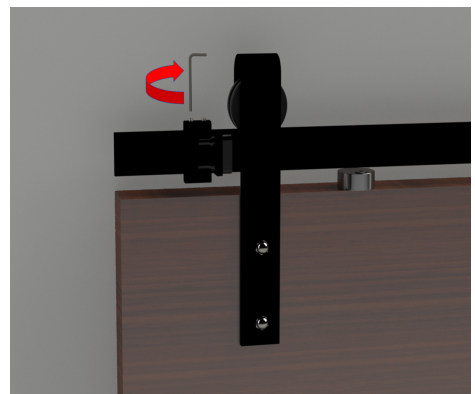
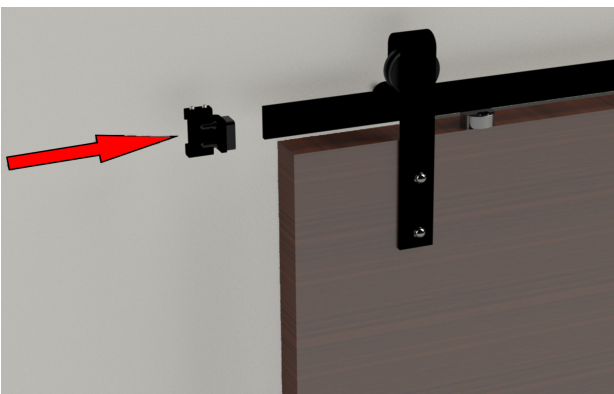

With door in fully closed position, insert track stop until rubber touches the hanger and secure with screws on the top of the track with the allen key provided.

## Step 6 Guide

### Concealed guide prep



1. With the door fully open. Position the guide in the middle of the channel. Ensure door is levelled and plumb



2. Insert half of the guide into the channel so that half of the guide is sticking out



3. Secure the guide using one of the screws provided



4. Slide the door to the closed position.



5. The other half of the guide should be sticking out now



6. Secure the guide in place with the remaining screw.

### Two Guide option (No Routing)



Position the two guides either side of the door so the door can move between the two guides



When happy with the position of the guides, secure with screws provided. Ensure door is levelled and plumb