

# HIDEAWAY™ SERIES POCKET DOOR SYSTEM ASSEMBLY INSTRUCTIONS

## HIDEAWAY Pocket System with New Steel Studs



\* One type of Floor brackets supplied which give 57mm gap, 90mm pocket thickness, 115mm finish wall thickness

\*\*Allows for carpet + underlay

\*\*\*See 61911-Guide for more details and options

61613 widening kit gives 63mm gap, 96mm pocket, 121mm finish wall thickness

Maximum door weight 90kg

DH - Door height, maximum 2743mm

DWi - Door width, maximum 1524mm

DT - Door thickness,

Minimum 25mm with standard bracket  
Maximum 44mm with standard bracket  
Maximum 50mm with cavity widening kit

OW - Opening width

OH - Opening height

### NOTE:

For door over 44mm  
61613 widening kit MUST be used.

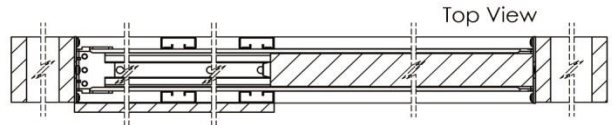
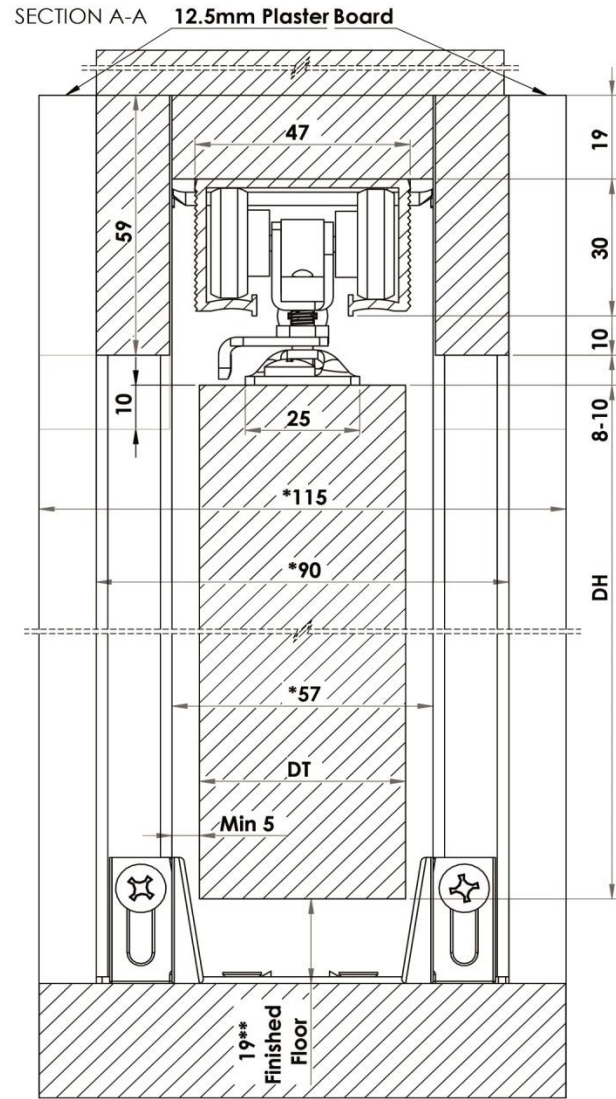

SECTION B-B  
SCALE 1 : 6

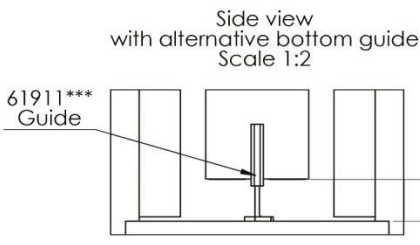
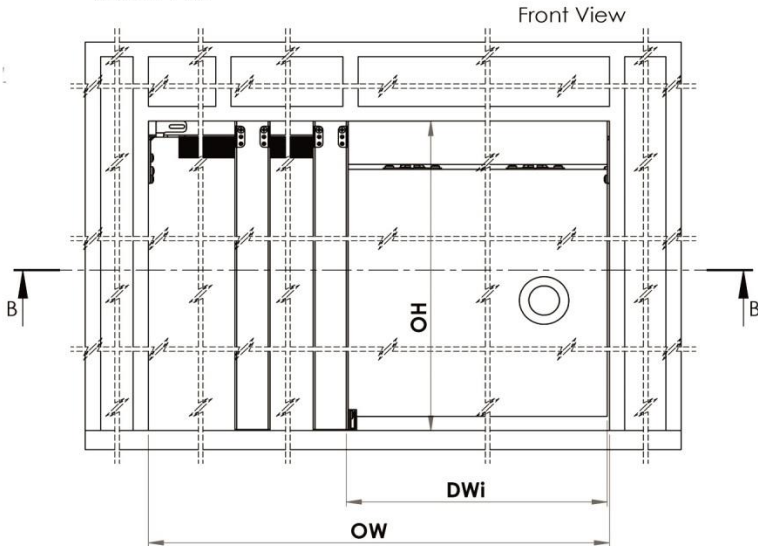

## Product Range Sizes

Available Sets				
Part No.	Item Code	Maximum Door Width	Maximum Door Height	Maximum Door Weight
61730	H30	762mm	2040mm	56kg
61736	H36	915mm	2040mm	56kg
61742	H42	1067mm	2040mm	90kg
61842	H42A	1067mm	2743mm	90kg
61848	H48A	1219mm	2743mm	90kg
61854	H54	1371mm	2743mm	90kg
61860	H60A	1524mm	2743mm	90kg



### IMPORTANT!

Before proceeding with the assembly carefully inspect the packaging to make sure the components have not been damaged during transit.

### IMPORTANT!

Opening height must be measured from finished floor level (taking account of any flooring)  
Opening must be square, plumb with studs and level.

### Door meeting require 2 kits and the 61600 jointing kit

#### Note!

Instructions are for a 2040mm door, if door is shorter, lower header and cut bottom ends of Split Studs.  
All purpose frames, marked to cut to shorter length

## CONTENTS

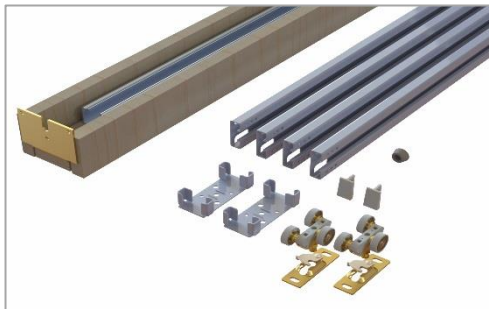

61730/736/742/842/848/854/860 – POCKET  
DOOR KIT

## ACCESSORIES

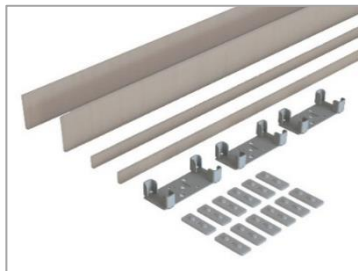

61613 –CAVITY WIDENING KIT (45mm TO 50mm  
THICK DOORS)



61700 – COMPONENT KIT

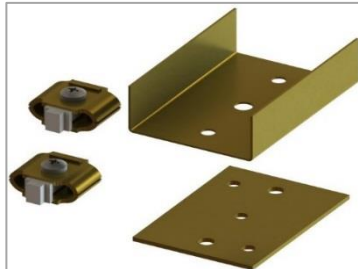

61600 – JOINTING KIT



61604 – HANGER, 56kg



61607 – HANGER, 90kg



61606 –DOOR STOPS (5pcs), DOOR MOUNTED

## ACCESSORIES (CONTINUED)



61911 – CONCEALED GUIDE

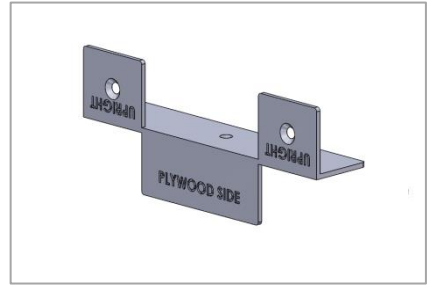

61615 – PLYWOOD REINFORCEMENT BRACKET SET



61611 – DOOR STOP, TRACK MOUNTED



61910 – BOTTOM GUIDE



95604 – POCKET DOOR 'HOLD OPEN' PISTON



30636 – CONCEALED SOFTCLOSER FOR H42, H42A, H54, AND H60A KITS



30642 – CONCEALED SOFTCLOSER FOR H30 AND H36 KITS.



61405 – SIMULTANEOUS SYNCHRO KIT FOR DOORS UP TO 1200MM WIDE

# Step 1 Opening preparation

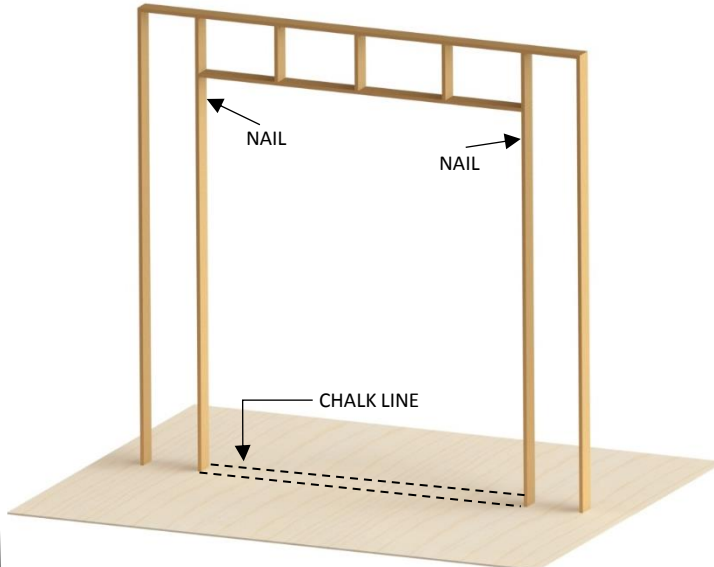
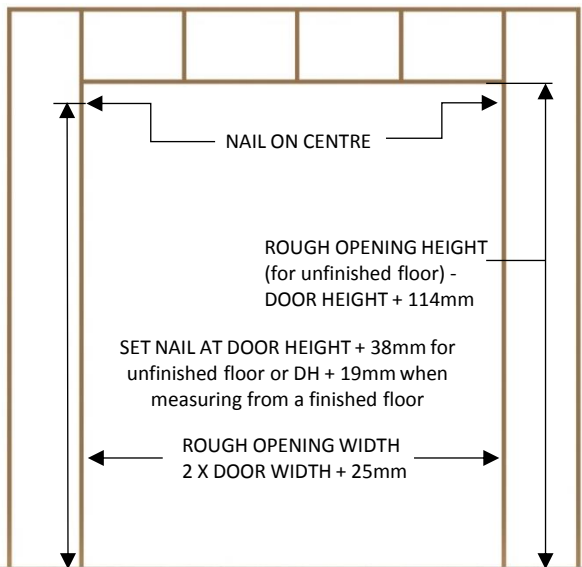

CONSTRUCT A ROUGH OPENING. The Header must be square and plumb with studs and LEVEL.

Minimum height is 2140mm, width is 2 x Door Width + 25mm.

NB: Instructions are for 2040mm high doors.

MEASURE up from the finished floor 2056mm or from the sub-floor 2075mm. This will give 19mm to 38mm clearance under the door.

Mark each rough stud and drive a flat head nail in the centre, leaving 3mm protruding. (Frame header end brackets will rest on these nails).

# Step 2 Prepare track / header

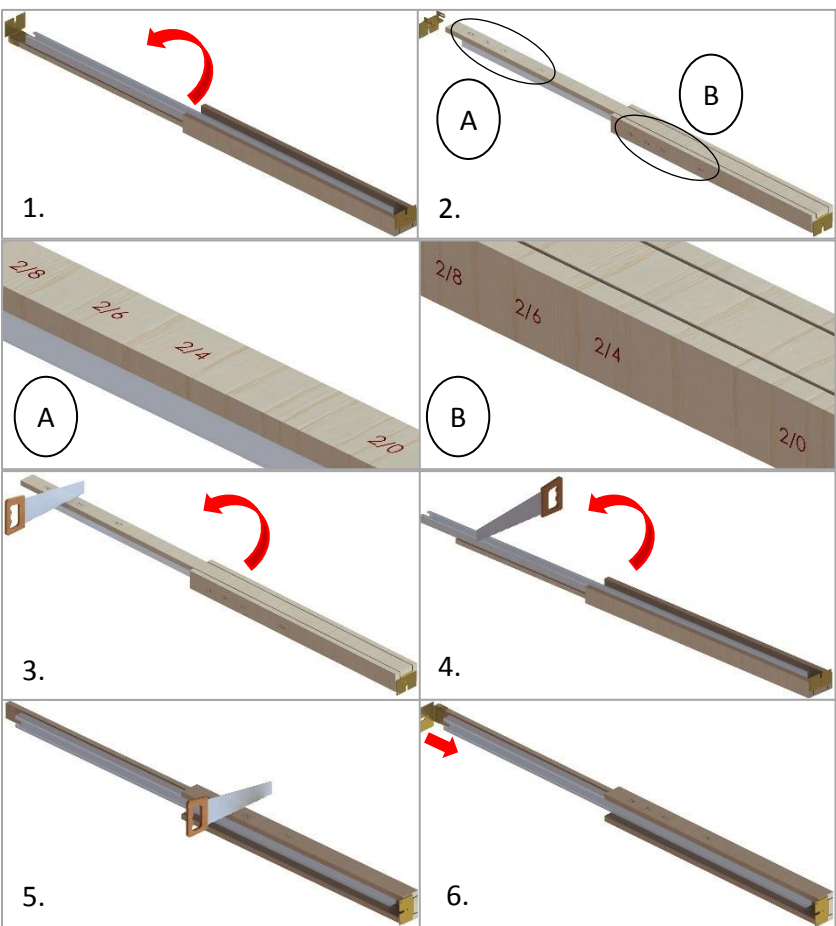

1. Take the track/header and place it on a flat surface with the wooden head facing down.
  2. Remove end bracket and turn the header over.
  3. Cut the wood header ONLY, at desired door size. Use markings. DO NOT CUT THE TRACK;
- $2/8 = 810\text{mm (32'')}$   
 $2/6 = 760\text{mm (30'')}$   
 $2/4 = 710\text{mm (28'')}$   
 $2/0 = 610\text{mm (24'')}$
4. Turn the assembly with the wood head facing down and cut the aluminium track 35mm shorter than the wooden header;
  5. Turn header on the side and cut the trim board ONLY, on each side at door size, use markings;
  6. Put back the end bracket at the end of the wooden head.



### Step 3 Mark the floor

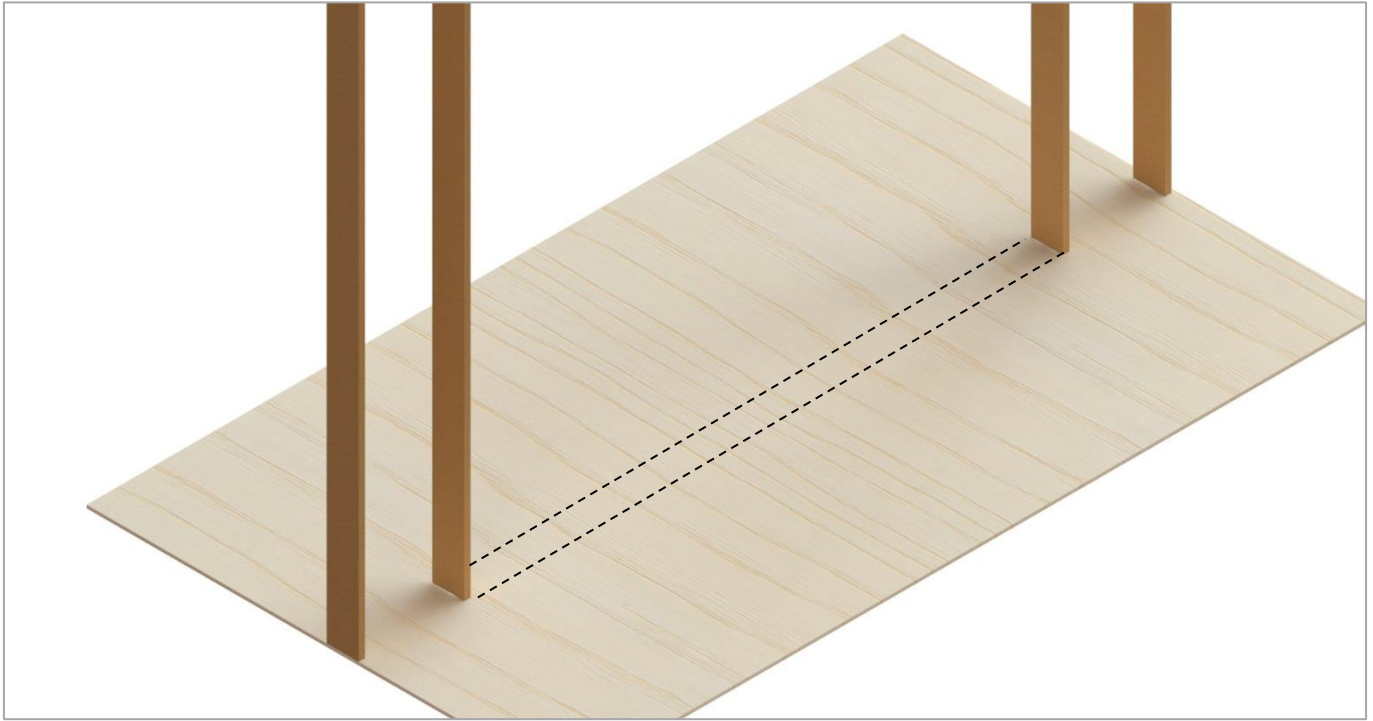

Make a straight chalk line on each side of the side studs to help define the pocket edges.

### Step 4 Position the track / header

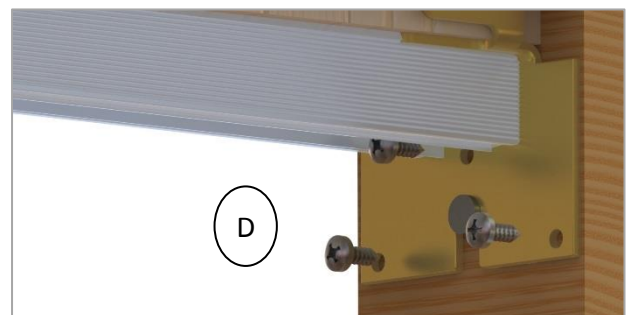
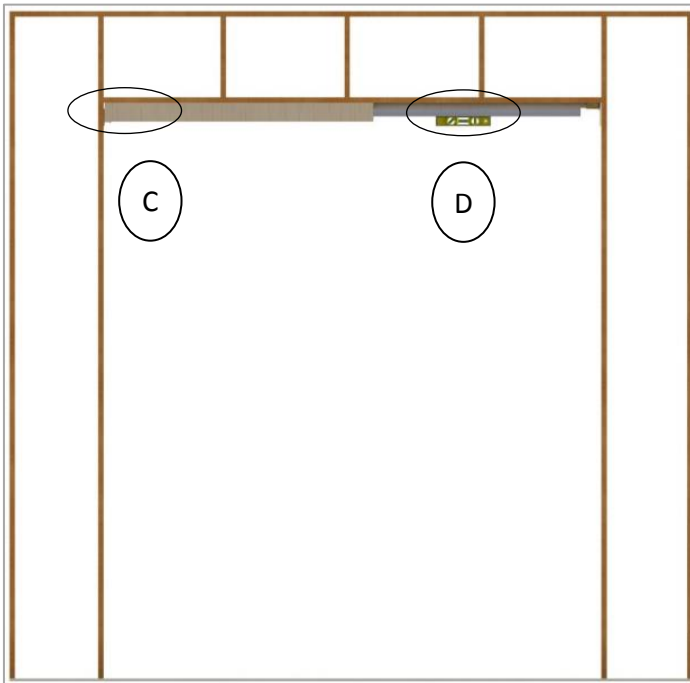

Insert the track into the opening over the nails.  
After ensuring the track is level, secure the end brackets with screws.

NB: If a simultaneous operator was opted for please refer to the instructions provided with it.

## Step 5 Prepare steel studs

### IMPORTANT!

Before proceeding with step 5, ensure the studs are straight.  
i.e. no damage has occurred during transit.

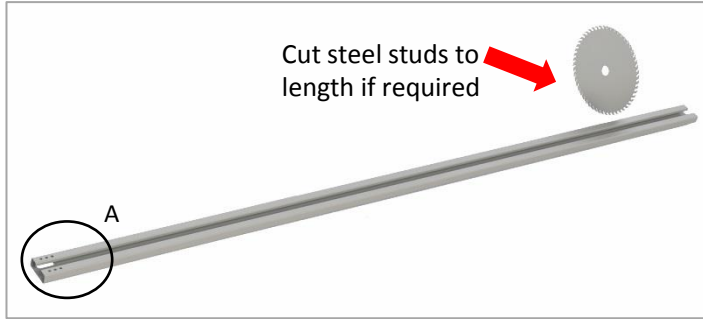

Measure and cut the split stud to the overall opening height (H).



**NB:** Do not cut the top end of the steel stud.

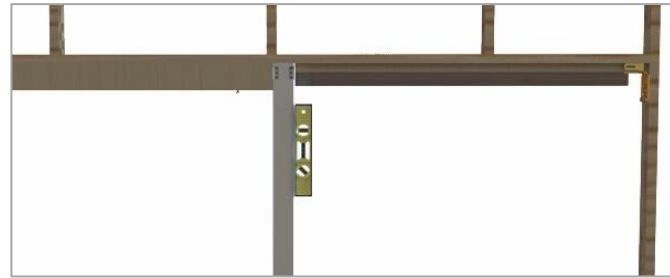
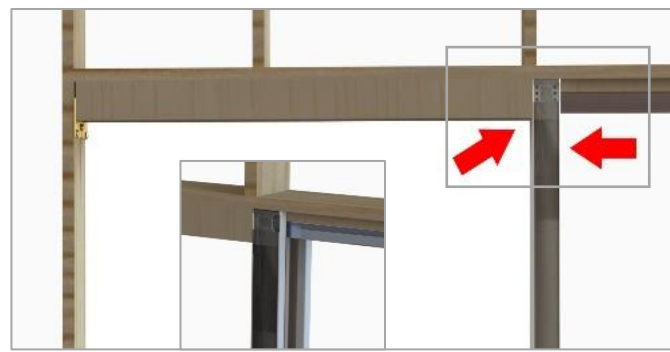

Position the first steel stud on the track and butt it up to the header and check with a spirit level that the stud is straight and plumb.

**NB:** For doors over 44mm thick, up to 50mm, use a cavity widening kit ( Part no: 61613). Please refer to the instructions provided with it.

## Step 6 Installing steel studs overview

If kit supplied has 4 steel studs, the first set of 2 will be placed on the track and butted up to the header.

The remaining set will be placed on the track and equally spaced between the first set and the side stud.

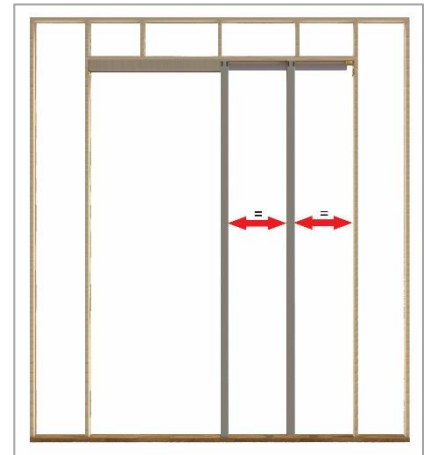

If kit supplied has 6 steel studs, the first set of 2 will be placed on the track and butted up to the header.

The remaining 2 sets will be placed on the track and equally spaced between each other, the first set (already installed) and the side stud.

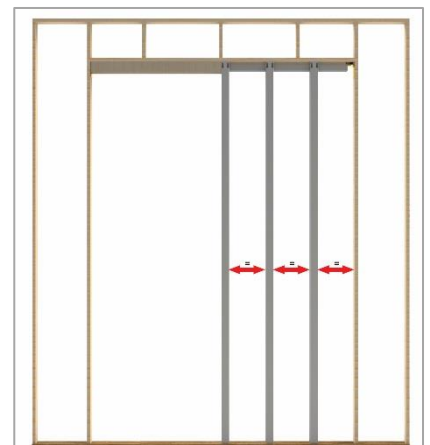

## Step 7 Fixing split studs into floor plate

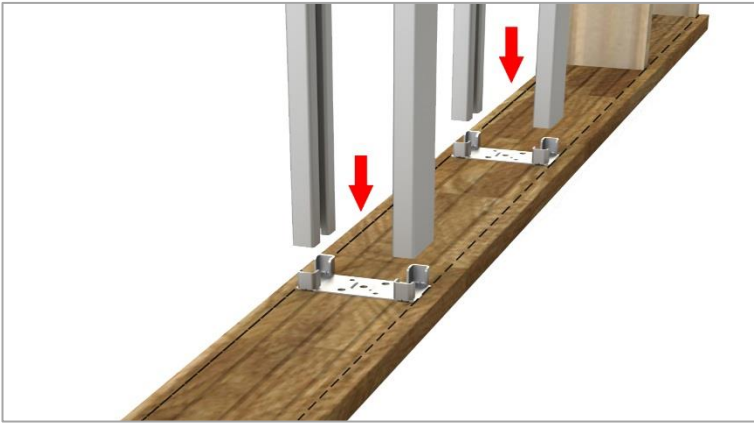

Slip floor plate tabs into steel studs.

**DO NOT FIX THE PLATE TO THE FLOOR.**

**NB:** If a widening kit was opted for please refer to the instructions provided with it.

## Step 8 Fixing split studs onto track

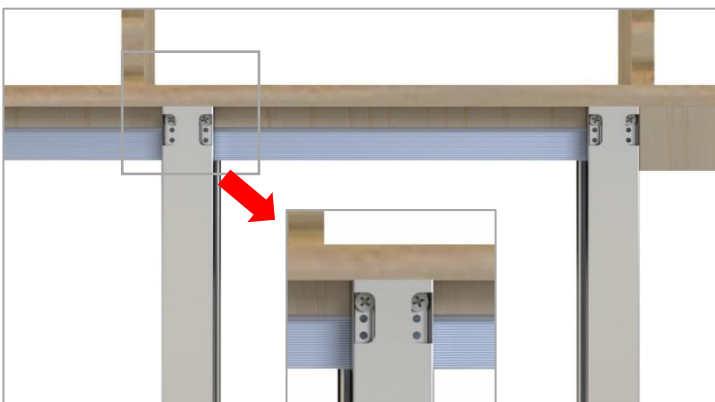

Fix the first set of steel studs by butting them to the header and the track, make sure they are vertical, and fix them with screws.

Fix the second pair of studs by butting them to the track equally spaced between the first set and the side stud, make sure they are vertical and fix them with screws.

**WARNING:** Make sure the screws are fixed into the wooden header and not into the track.

## Step 9 Fixing floor plates to floor

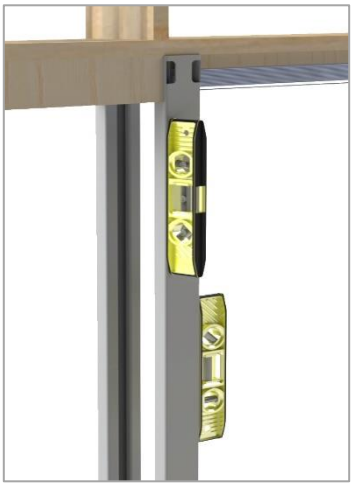
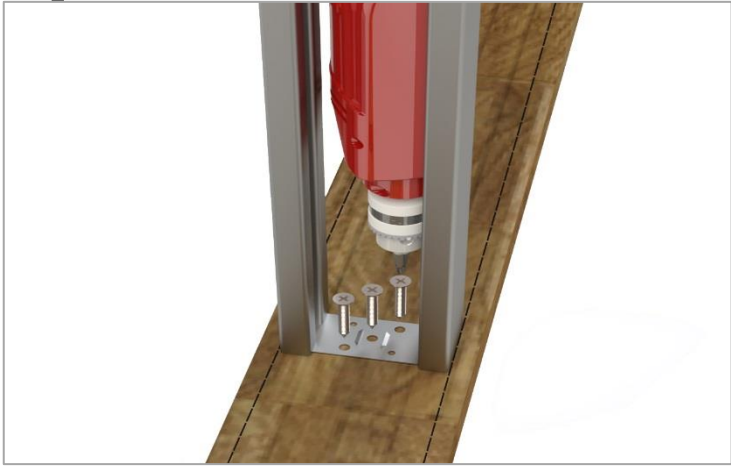

Ensure studs are upright. To double check that everything is straight the floor plate must be located in the middle of the chalk lines.

Secure the floor plate with screws.

## Step 10 Door preparation: installing hanger plates



Attach the door plates on top of the door 50mm from the edges.

NB: The lock tabs MUST be on the same side



If a soft closer or a simultaneous operator was opted for please refer to the instructions provided with it.



# Step 11

Door preparation: rear bumper

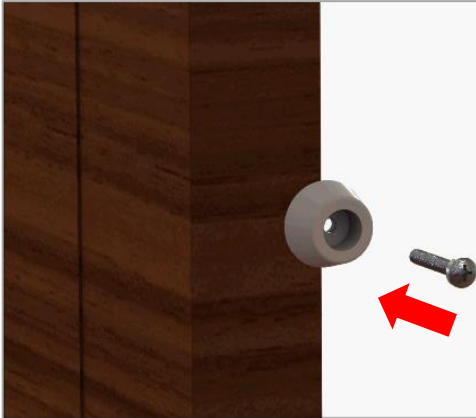

Attach bumper at the back of the door 1000mm from the bottom.

If a holdback piston was opted for please refer to the instructions provided with it.

# Step 12

Insert hangers into track

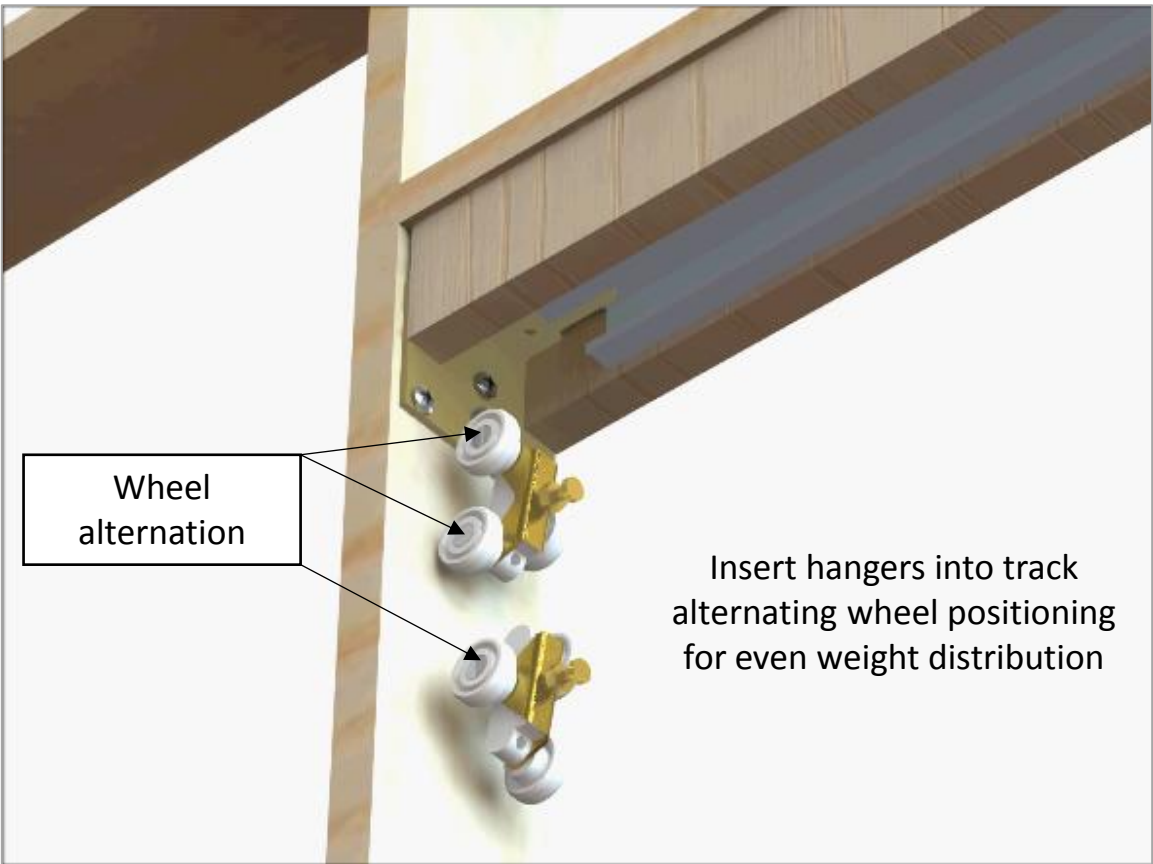

# Step 13 Door installation

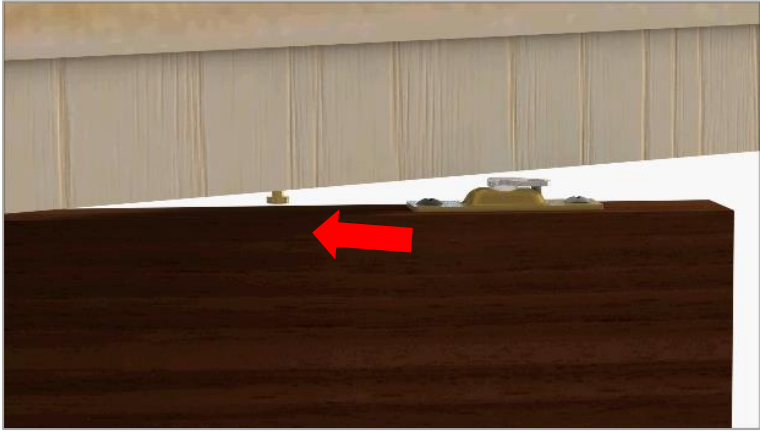

Position the hanger in the middle of the opening and angle the door into the pocket

Line up the hanger with the door plate. Insert the hanger pin and secure with the locking catch.

# Step 14 Door installation continued.

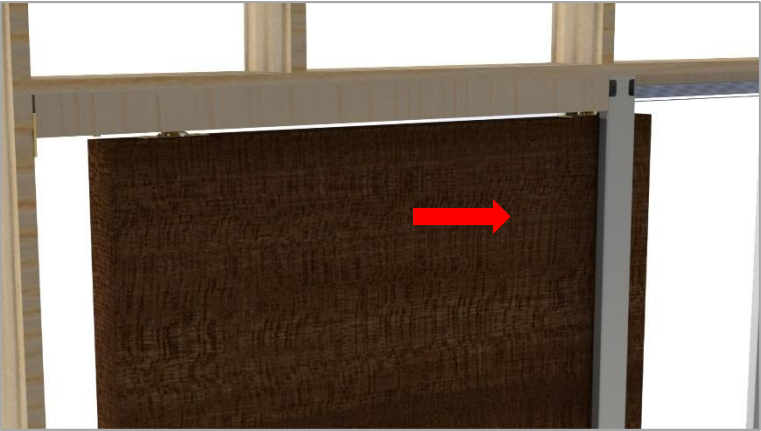

Slide the door part way inside the pocket to ease the mounting of the second door plate.

Insert hanger pin into the second door plate slot and secure with the locking catch.

## Step 15 Secure hanger pins

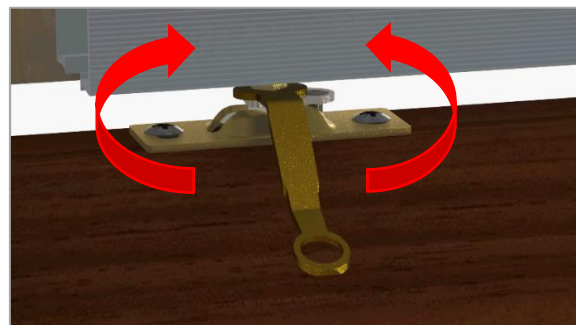
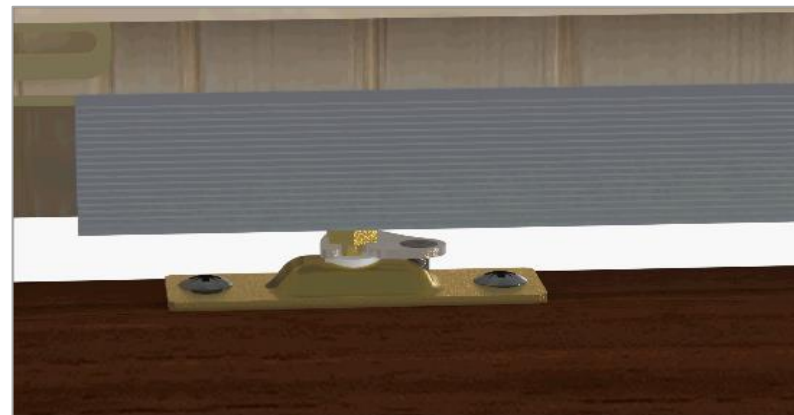
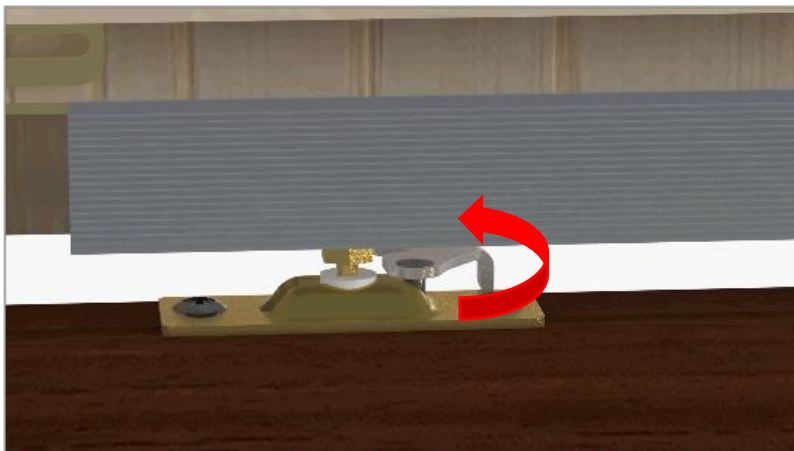

After pins are fully inserted and locked into the door plates adjust the height of the door by rotating the hanger bolt with the special spanner supplied with the kit.

## Step 16 Finishing pocket wall



Use plaster board to cover the pocket wall. Line up the edge of the plaster board so that it is flush with the edge of the opening.

**NOTE:** Use self tapping screws supplied with the kit.

After the plaster board has been applied the architrave can be installed

\*(Not supplied by Coburn)

## Step 17 Install bottom guides

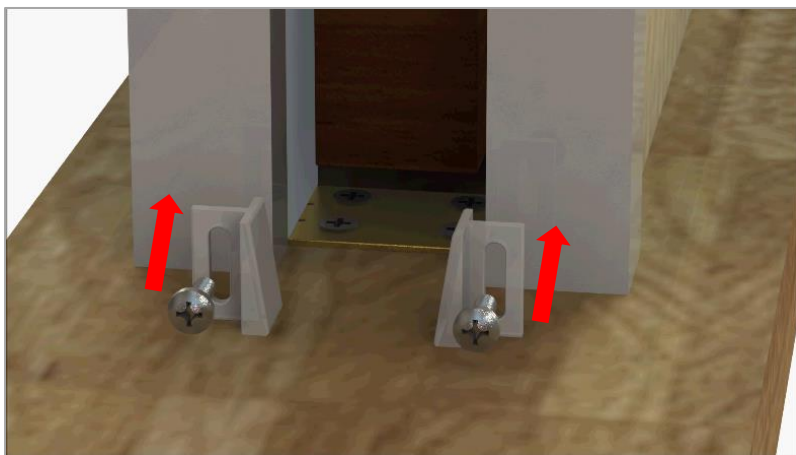

After installing the architrave, install the bottom guides.

Secure guides with the screws provided

NB: If a different guide was opted for please refer to the instructions provided with it.



# HIDEAWAY™ SERIES

## Fitting instructions

Coburn Sliding Systems Limited

Unit 1, Cardinal West,

Godmanchester, PE29 2XN, United Kingdom

Phone: +44 (0)20 8545 6680

E-mail: [sales@coburn.co.uk](mailto:sales@coburn.co.uk)

[www.coburn.co.uk](http://www.coburn.co.uk)

